

CODE:

6382

TYPOLOGY:

recessed spot

MATERIALS:

aluminium

LIGHT:

LED

BULBS:

/W - LED 1W 350 mA 151lm 4000K

/WW - LED 1W 350mA 143lm 3000K

/B - LED BLUE

IP GRADE:

IP20

NET WEIGHT:

0,02 Kg

FINISHING:

.01 white

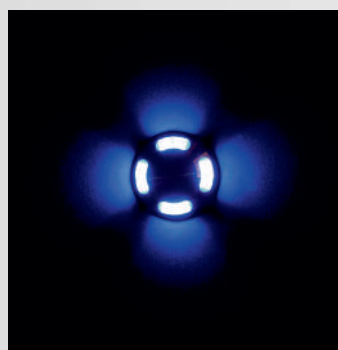
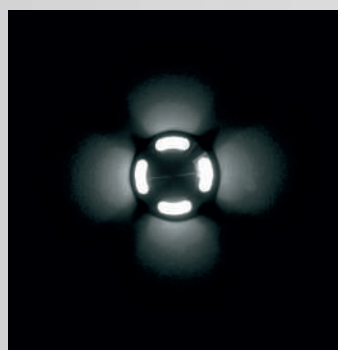

DIMENSIONS:

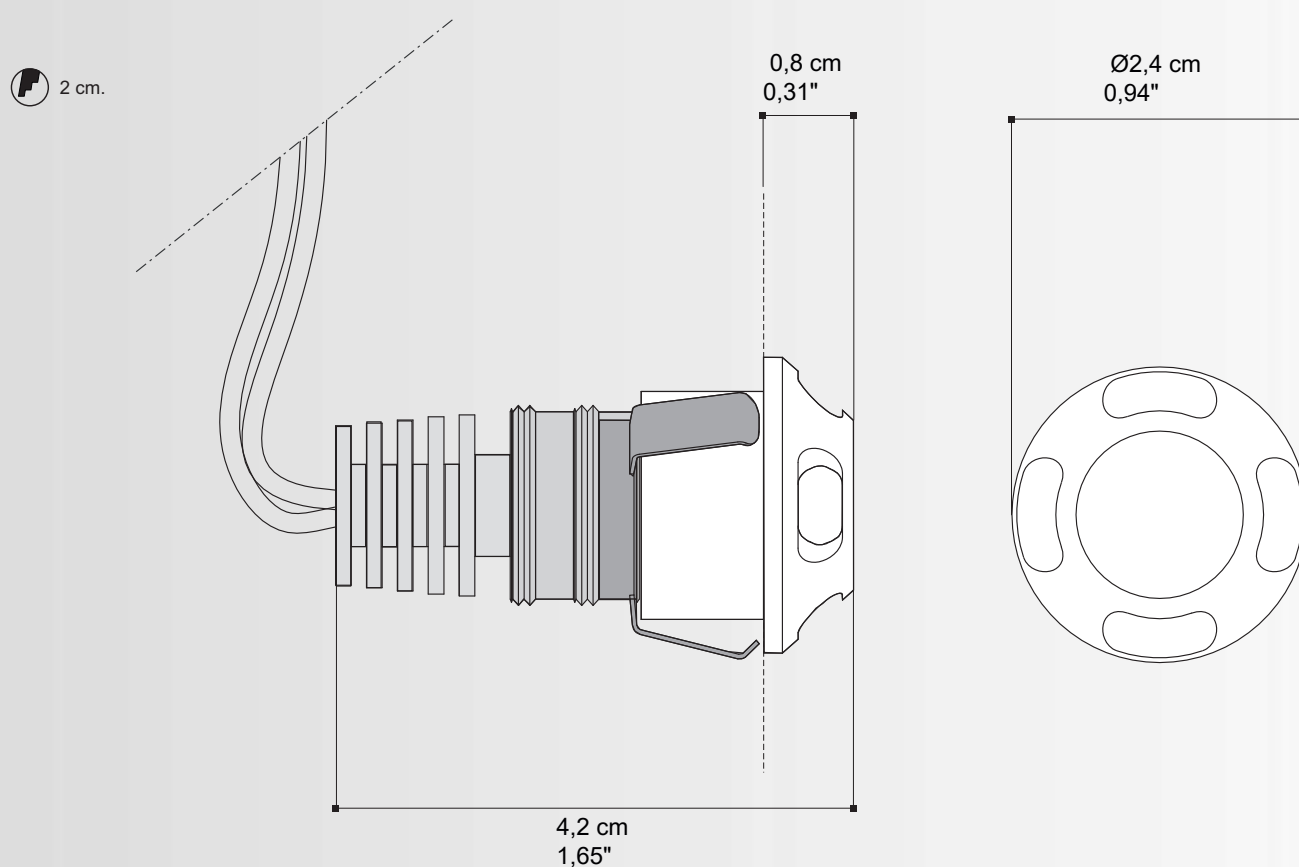

ONLY SERIAL CONNECTION

WE WELCOME ALL CUSTOM ORDERS!

IES files upon Request

ACCESSORIES:

LED DRIVERS constant current.

0128

LED driver
IN: 100 - 240V
OUT: 350 mA
1-10 Power LED 1W

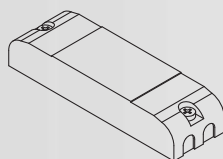

11,6 x 3,4 x 2 cm



0136/15

LED driver
IN: 100 - 240V
OUT: 350 mA
1-10 Power LED 1W

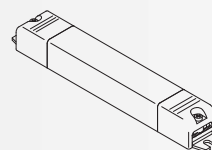

15,8 x 2,2 x 2 cm

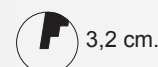

DIMMABLE LED DRIVERS constant current.

0129 Dimmer Led

Multipower dimmable driver
IN: 110 - 240V
OUT: 350 mA, 4-15 Power LED

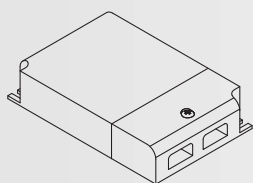

10,5 x 7 x 2,2 cm



0129/DALI Dimmer Led

Multipower dimmable driver IN: 110 - 240V
OUT: 500 mA, 2-12 Power LED

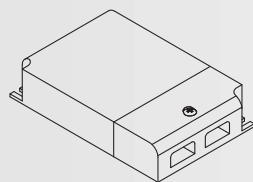

10,5 x 7 x 2,2 cm



0141/DALI

LED driver
IN: 110 - 240V
OUT: 500 mA, 1-11 Power LED

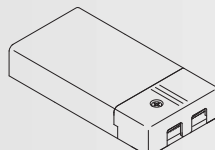

11,1 x 5,2 x 2,5 cm



0141/DIM

LED driver
IN: 110 - 240V
OUT: 350 mA, 1-12 Power LED

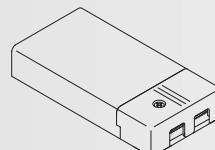

PUSH version not synchronizable

11,1 x 5,2 x 2,5 cm



0145 Dimmer Led Maxi

Multipower dimmable driver
IN: 110 - 240V
OUT: 350 mA, 1- 21 power LED

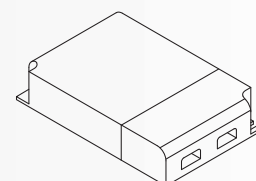

12,3 x 8 x 2,2 cm



0145/DALI Dimmer Led Maxi

Multipower dimmable driver
IN: 110 - 240V
OUT: 350 mA, 1-21 power LED

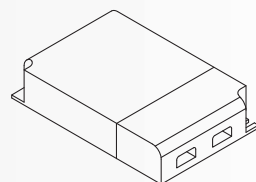

12,3 x 8 x 2,2 cm



0133

Sincronization cable for dimmer Led
(art. 0129 - art. 0129DALI - art. 0145 - art. 0145DALI)



Lunghezza: 150cm.

WE WELCOME ALL CUSTOM ORDERS!

IES files upon Request