



CODE:

6391

TYPOLOGY:

recessed lamp

MATERIALS:

aluminium

LIGHT:

direct

BULBS:

/W - LED max 2W 500 mA 209lm 4000K /

WW - LED max 2W 500 mA 199lm 3000K

IP GRADE:

IP 40

NET WEIGHT:

0,04 Kg

FINISHING:

.01 white

.45 aluminium anodized

DIMENSIONS:

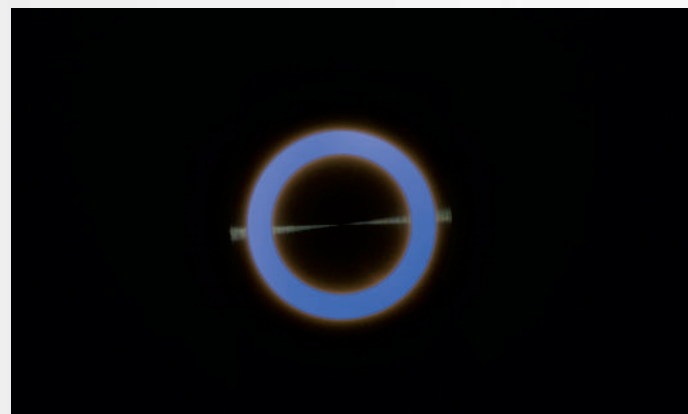
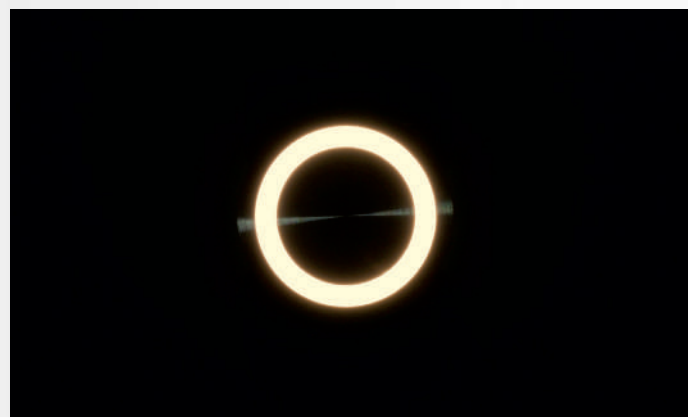
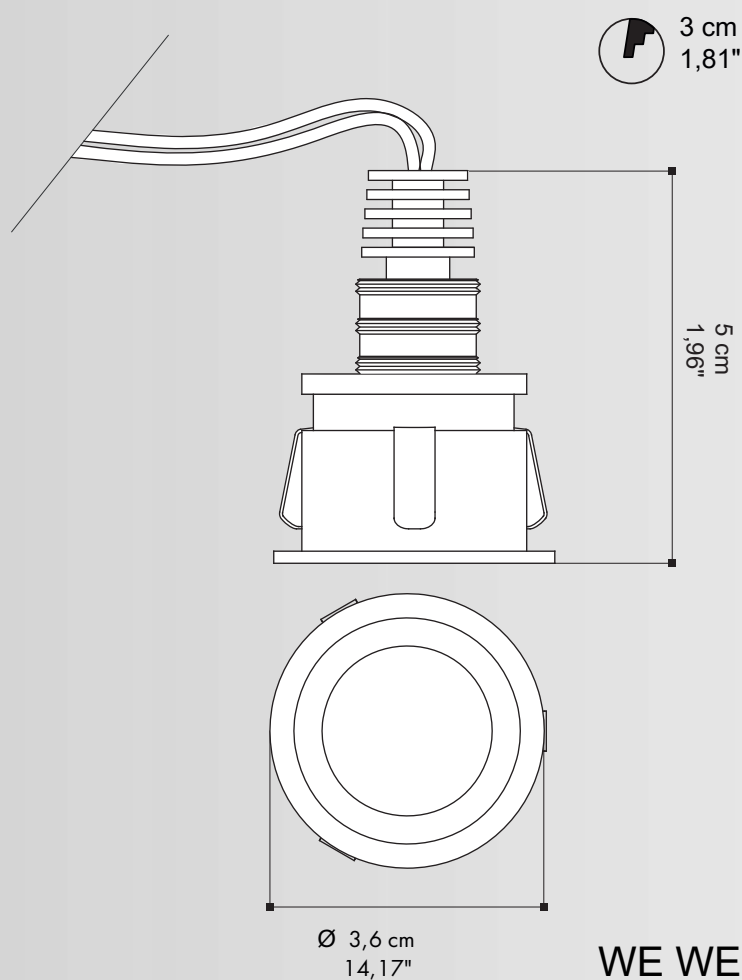

WE WELCOME ALL CUSTOM ORDERS!

IES files upon Request

ONLY SERIAL CONNECTION

ACCESSORIES:

LED DRIVERS constant current.

0127

LED driver
 IN: 100 - 240V
 OUT: 500 mA
 1-6 Power LED 2W
 1-6 Power LED 2W - art.0120-0122

11,6 x 3,4 x 2 cm

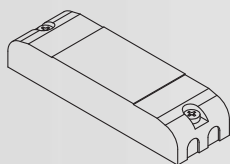

DIMMABLE LED DRIVERS constant current.

0129 Dimmer Led

Multipower dimmable driver
 IN: 110 - 240V
 OUT: 500 mA, 1-14 Power LED

10,5 x 7 x 2,2 cm

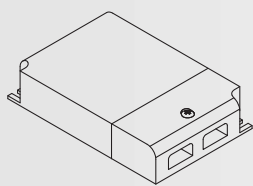
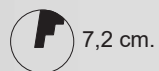

0129/DALI Dimmer Led

Multipower dimmable driver IN: 110 - 240V
 OUT: 500 mA, 2-12 Power LED

10,5 x 7 x 2,2 cm

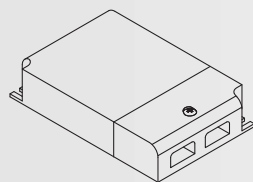

0141/DALI

LED driver
 IN: 110 - 240V
 OUT: 500 mA, 1-11 Power LED

11,1 x 5,2 x 2,5 cm

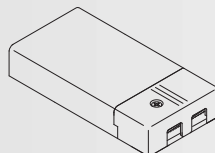

0141/DIM

LED driver
 IN: 110 - 240V
 OUT: 500 mA, 1-11 Power LED

PUSH version not synchronizable

11,1 x 5,2 x 2,5 cm

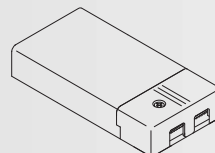

0145 Dimmer Led Maxi

Multipower dimmable driver
 IN: 110 - 240V
 OUT: 500 mA, 1-21 power LED

12,3 x 8 x 2,2 cm

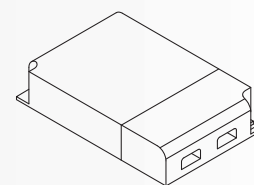

0145/DALI Dimmer Led Maxi

Multipower dimmable driver
 IN: 110 - 240V
 OUT: 500 mA, 1-21 power LED

12,3 x 8 x 2,2 cm

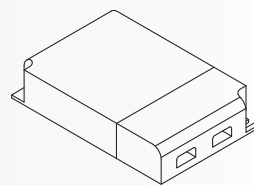

0133

Sincronization cable for dimmer Led
 (art. 0129 - art. 0129DALI - art. 0145 - art. 0145DALI)



Lunghezza: 150cm.

WE WELCOME ALL CUSTOM ORDERS!

IES files upon Request