

ALCOR

6360



CODE:

6360

TYPOLOGY:

recessed lamp

MATERIALS:

crystal - aluminium

LIGHT:

diffuse

BULBS:

/W - LED 1W 350 mA 151lm 4000K

/WW - LED 1W 350mA 143lm 3000K

IP GRADE:

IP 44

NET WEIGHT:

0,03 Kg

FINISHING:

.50 crystal



DIMENSIONS:

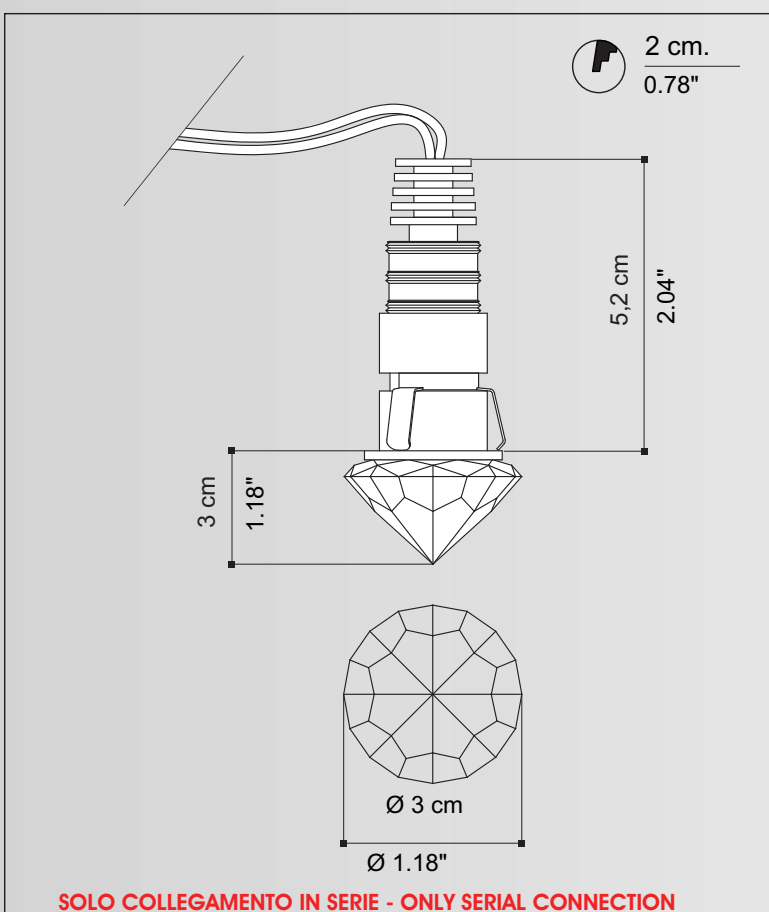

WE WELCOME ALL CUSTOM ORDERS!

IES files upon Request

### ACCESSORIES:

#### LED DRIVERS constant current.

##### 0128

**LED driver**  
IN: 100 - 240V  
OUT: 350 mA  
1-10 Power LED 1W

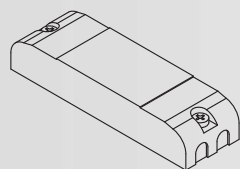

11,6 x 3,4 x 2 cm



##### 0136/15

**LED driver**  
IN: 100 - 240V  
OUT: 350 mA  
1-10 Power LED 1W

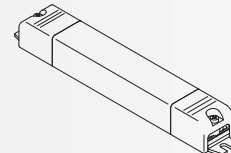

15,8 x 2,2 x 2 cm



#### DIMMABLE LED DRIVERS constant current.

**0129 Dimmer Led Multipower dimmable driver**  
IN: 110 - 240V  
OUT: 350 mA, 4-15 Power LED

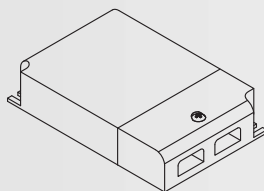

10,5 x 7 x 2,2 cm

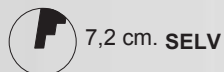

**0145 Dimmer Led Maxi Multipower dimmable driver**  
IN: 110 - 240V  
OUT: 350 mA, 1- 21 power LED

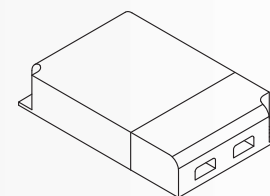

12,3 x 8 x 2,2 cm

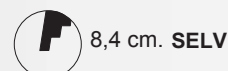

**0129/DALI Dimmer Led Multipower dimmable driver**  
IN: 110 - 240V  
OUT: 350 mA, 2-12 Power LED

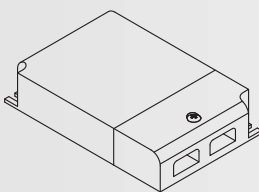

10,5 x 7 x 2,2 cm



**0145/DALI Dimmer Led Maxi Multipower dimmable driver**  
IN: 110 - 240V  
OUT: 350 mA, 1- 21 power LED

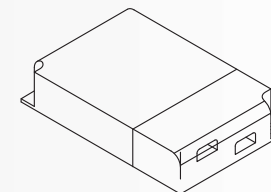

12,3 x 8 x 2,2 cm

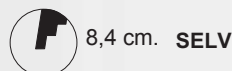

##### 0141/DALI

**LED driver**  
IN: 110 - 240V  
OUT: 350 mA, 1-12 Power LED

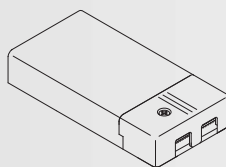

11,1 x 5,2 x 2,5 cm



##### 0133

Sincronization cable for dimmer Led  
(art. 0129 - art. 0129DALI - art. 0145 - art. 0145DALI)

Length: 150 cm



##### 0141/DIM

**LED driver**  
IN: 110 - 240V  
OUT: 350 mA, 1-12 Power LED

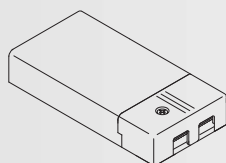

PUSH version not synchronizable

11,1 x 5,2 x 2,5 cm

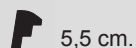

WE WELCOME ALL CUSTOM ORDERS!

IES files upon Request