

GENERAL INFORMATION:

MATERIAL:	PMMA
LIGHT SOURCE:	White LED light engine
LUMEN MAINTENANCE:	L70 life = 50,000+ hours
EFFICACY:	Up to 83 lm/W delivered
CCT:	3000K, 3500K, or 4000K
VOLTAGE:	110-277V
DIMMING:	0-10V
DIFFUSER:	White matte acrylic diffuser standard; white gloss acrylic diffuser on request*

[A] TYPE OF THE FIXTURE:

P47.04	APOLLO 2 HORIZONTAL
P47.12	APOLLO 2 VERTICAL
P47.55	APOLLO 2 ANGLE (specify the mounting angle needed)

[B] BULB:

10.	LED 700mA 4000K 90 CRI
20.	LED 700mA 3500K 90 CRI
30.	LED 700mA 3000K 90 CRI

NOMINAL LUMEN PACKAGES ACCORDING TO THE CHOSEN TUBES LENGHT:

60cm(23.62"), 12W, 1400Lm	120cm(47,24"), 40w, 3400Lm	180cm(70,86"), 68w, 5400Lm
90cm(35,43"), 20w, 2410Lm	150cm(59,05"), 55w, 4450Lm	

[C] TYPE OF CANOPY:

F.	5" Flat Canopy
B.	1/2" Button Canopy
CUS*	Custom

WE WELCOME ALL CUSTOM ORDERS!

IES files upon Request

[D] ENDCUP AND CANOPY FINISH OPTIONS:

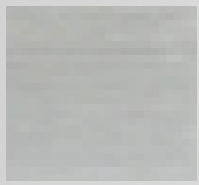

.AN Clear Anodised

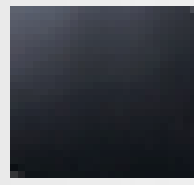

.AB Black Anodised

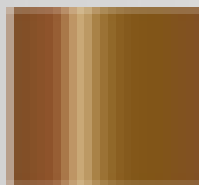

.BZ Bronze

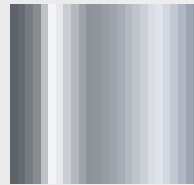

.CR Chrome Plated

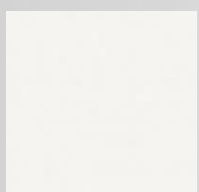

.WH White Powder Coated

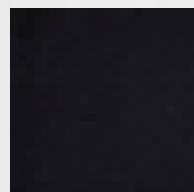

.BK Black Powder Coated

.NN - Without Endcup

.XX - Color on Request

[E] LENGTH OF THE FIXTURE:

12" / 24" / 36" / 48" / 60" / 72"

Notice: Custom sizes available, put in order code CUS (and a needed size in inches)

[F] CORD LENGTH:

10" / 15" / 20" / 25" / 30"

Notice: Custom lengths available, put in order code CUS (and a needed size in inches up to 30")

[G] DIAMETER OF THE FIXTURE TUBE:

1,5" / 2"

Notice: Custom diameters available, put in order code CUS (and a needed size in inches)

[H] AMOUNT OF TUBES ON THE CANOPY:

1 / 3 / 7 / 15 / 27 / Custom amount on request*

HOW TO ORDER:

A-B-C-D-E-F-G-H

FOR EXAMPLE: P47.04 - 20. - B. - .CR - 24" - 25" - 2" - 7

Apollo Horizontal - LED 700mA 9W 920lm approx. 3500K 90 CRI - 1/2" Button Canopy - Chrome Plated - 24" fixture length - 25" cord length - 2" tube diameter - 7 tubes on the canopy

WE WELCOME ALL CUSTOM ORDERS!

IES files upon Request

g@gordonbullard.com
www.cerchiolighting.com
269-569-6700



991 South Gull Lake Dr
Richland, MI 49083, USA
1 877-964-4646

EXAMPLES OF AVAILABLE CONFIGURATIONS:

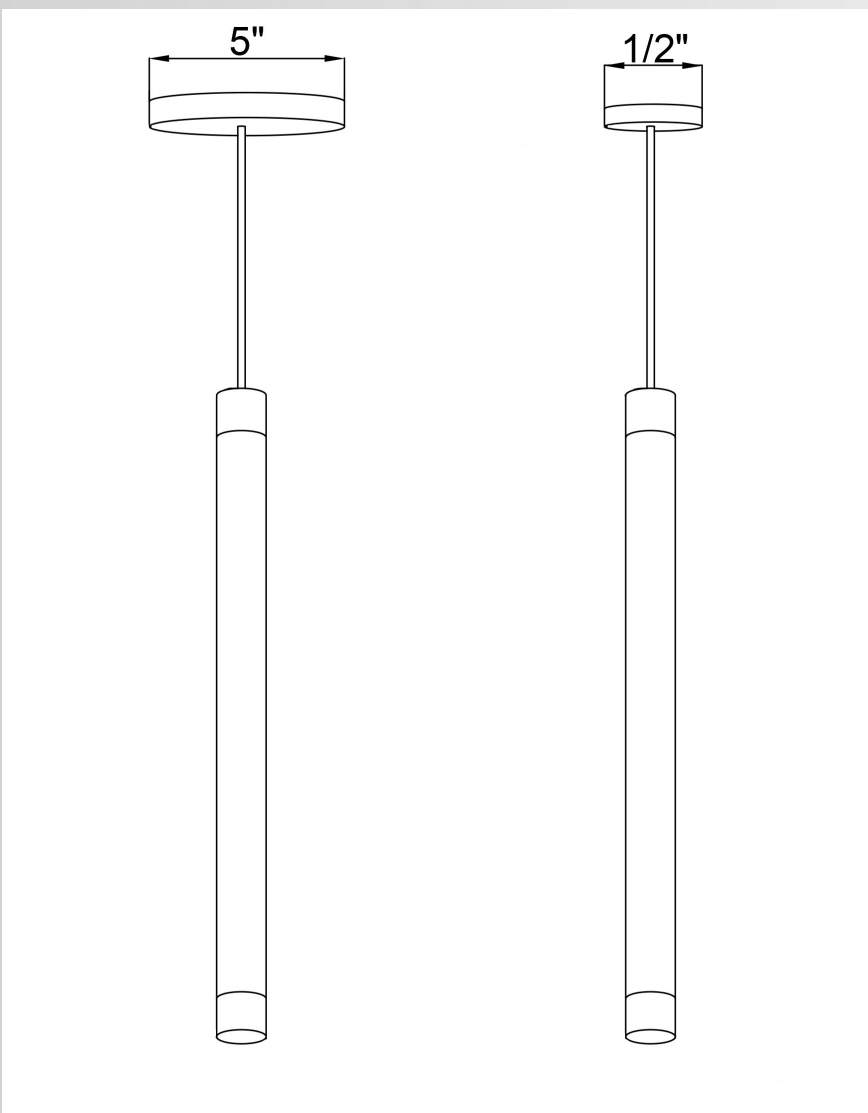
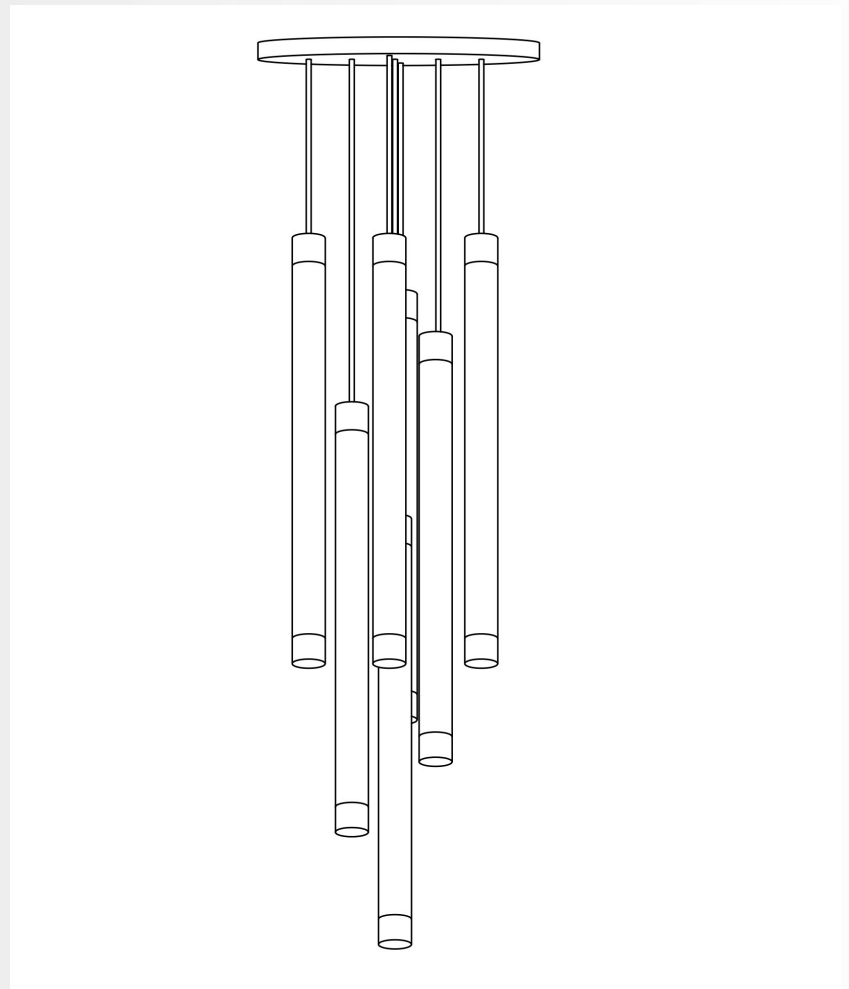

WE WELCOME ALL CUSTOM ORDERS!

IES files upon Request

g@gordonbullard.com
www.cerchiolighting.com
269-569-6700



991 South Gull Lake Dr
Richland, MI 49083, USA
1 877-964-4646